

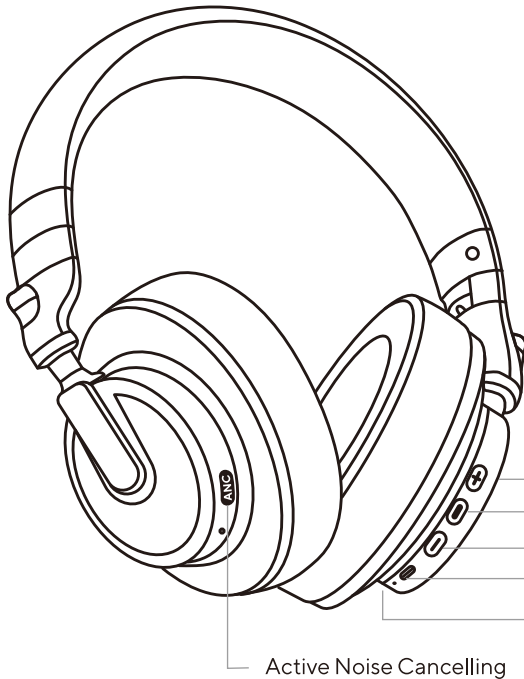





QUICK USER GUIDE

Damson ANC V2 Wireless Headphones



damsonglobal.com

	Press to increase the volume. Press and hold to skip to the next track.
	Press to decrease volume. Press and hold to return to beginning of track. Repeat quickly to go to the previous track.
 USB-Type C	Charging LED: Red indicates charging. Blue indicates charged.
	Press and hold to turn ANC on or off. When on the LED will light up green. Note: ANC has no automatic power off function. If left on the Headset will eventually run out of battery.
 3.5mm Jack	Connect to a device with a 3.5mm male to male cable. Note: When using a cable Bluetooth and the microphone are disabled.



Power Button



POWER ON/OFF:

Press and hold to power on or off
Press to Play/Pause audio from connected device



HANDSFREE PHONE CALL:

Answer: Press
End call: Press
Reject call: Press and hold
Last number redial: Double press
Voice Assistant: Double press
Press to answer/hang up.
Press and hold to reject call.
Press two twice to redial last outbound phone number or to activate voice assistant on compatible devices.

WARNING: Do not over extend the headband or cups outwards as this will result in a mechanical failure which is not covered under warranty.

Connection

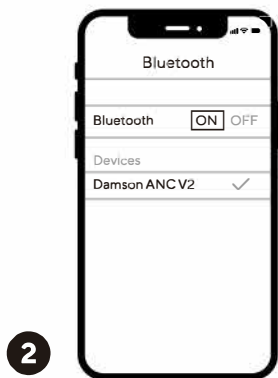
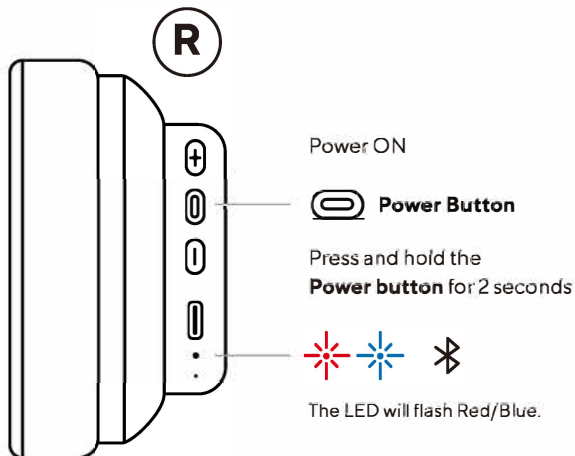
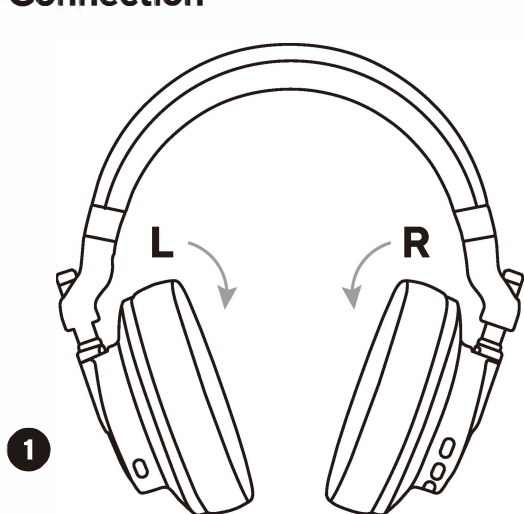

In your Device settings go to Bluetooth and search until you see "Damson ANC V2" and connect.

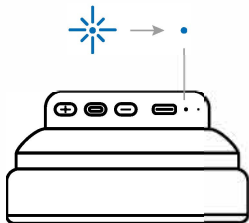

PAIRING TO FIRST DEVICE.

Press and hold the power button to turn the headset on. After 10 seconds the headset will enter pairing mode.

Note: If the headset has previously been connected to a device, which is in range, it will automatically connect to this and not enter pairing mode.

MULTI-POINT CONNECTION

Multi-point allows you to connect two devices to your Damson Headset at the same time. To connect a second device after you have connected the first to the headset; Disconnect the connected phone from the headset. The headset will enter pairing mode. Connect your second device by following the pairing guide as before.

Note: Only one device will play at a time. A good use case example for Multi-point is when listening to music, or streaming video from a tablet or laptop and still wanting to receive incoming calls. In this case the audio/video will be paused on the first device when a call is received allowing you to choose to answer, or reject, the incoming call.

Charging

BATTERY LOW INDICATOR.

When the battery enters its final 10% of power it will alert you that it requires charging in 15 minute intervals until the battery runs out completely or is charged. The LED will also flash red.

Wired Charging: Please plug Type-C USB into headphone charging port and connect the other side with USB wall charging adapter or computer.

Note: Always use a Wall socket plug e.g. Smartphone charger, that provides at least 2.1v 5a of output power. Do not use headphones whilst charging.

LED indicator turns red while charging, and turns blue when fully charged.

